

HA16605W

Burner Controller

Description

Recently burner control equipment has been improved and required to obtain small outline, high performance and multi functions. And now, electronic burner controller is going to become more popular to save energy and to have better safety functions.

The HA16605W is a one chip monolithic IC, integrated of the sequential control part in the burner control equipment. This IC has hour sequence control modes, so that it can provide functions for various burner systems.

In each mode, fail-safe functions are provided. And this IC has capability of drive relays directly.

Features

- Four kinds of fixed control sequence.
- Commercial frequency 50/60 Hz can be used for the clock pulse of internal timer.
- Transistors which can drive the power relay directly are built in.
- Comparators are built in.
- Provides safety functions.

Block Diagram

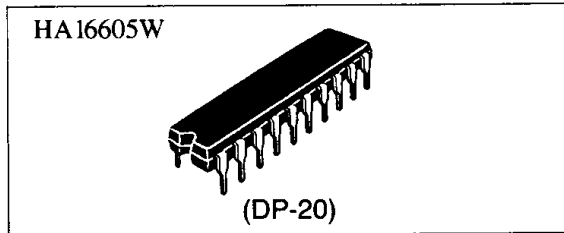
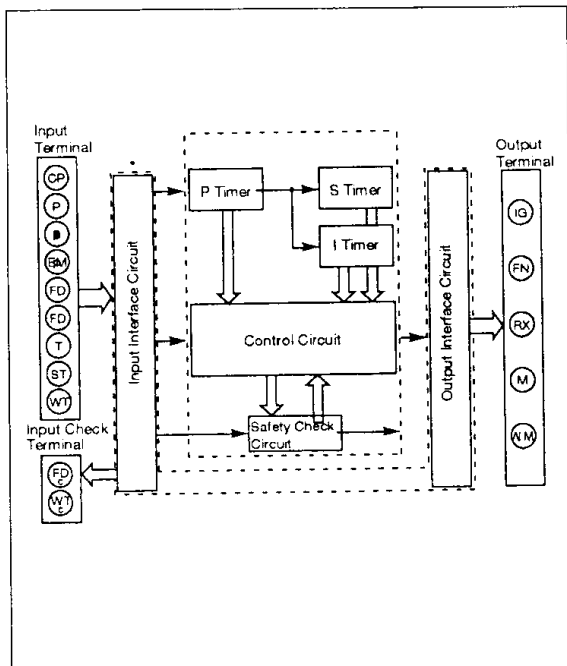

Pin Arrangement

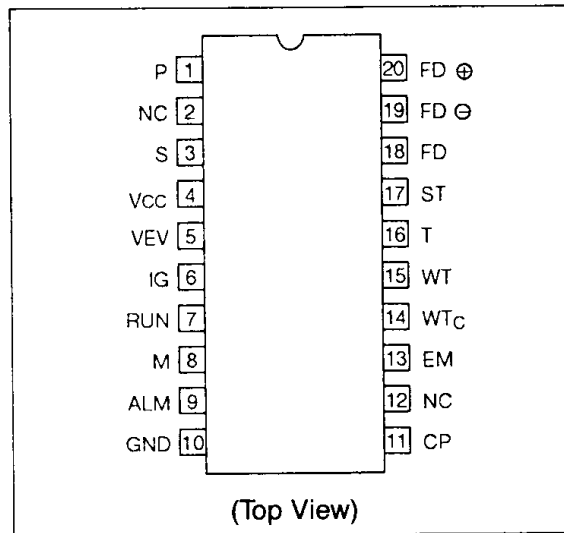

Ordering Information

Type No.	Package
HA16605W	DP-20

Pin Description

Pin No.	Symbol	Description
1	P	Decoder input to discriminate four kinds of control sequence
2	NC	Non connect
3	S	Decoder input to discriminate four kinds of control sequence
4	Vcc	Power supply
5	EV*	Power transistor output for driving the magnetic-valve
6	IG*	Power transistor output for driving the ignition equipment
7	RUN*	Power transistor output for driving the operation lamp
8	M*	Power transistor output for driving the blower motor
9	ALM*	Power transistor output for driving the alarm lamp
10	GND	GND
11	CP	Clock signal (50/50 Hz) input
12	NC	Non connect
13	EM	Emergency stop signal input
14	WTc	Output of the water temperature detection signal
15	WT	Input of the water thermo signal
16	T	Input of the reference voltage for the water thermo and for the safety thermo
17	ST	Input of the safety thermo signal
18	FDc	Output of the flame detection signal
19	FD _e	Input of the flame detection signal
20	FD _⊕	Input of the reference signal for the flame detection

* Open collector output of NPN transistor.

Absolute Maximum Ratings (T_a = 25°C)

Item	Symbol	Rating	Unit	Applied Terminal	Note
Supply Voltage	Vcc	7.0	V	Vcc	
Input Voltage	V _{IN}	-0.5 to Vcc + 5.0	V	CP, EM	
		-0.5 to Vcc + 1.0		P, S	
		-0.5 to Vcc + 3.0		FD _⊕ , FD _e , T, ST, WT	1
Output Voltage	V _{out}	-0.5 to Vcc + 3.0	V	FDc, WTc	
		-0.5 to +25		IG, EV, RUN, M, ALM	2
Output Current	I _{out}	2	mA	FDc, WTc	
		75		IG, EV, M, ALM	3
		100		RUN	
Power Dissipation	P _T	500	mW		
Operating Temperature Range	T _{opr}	-20 to +75	°C		
Storage Temperature Range	T _{stg}	-55 to +125	°C		

The absolute maximum ratings are limiting values, to be applied individually, beyond which the device may be permanently damaged. Functional operation under any of these conditions is not guaranteed. Exposing a circuit to its absolute maximum rating for extended periods of time may affect the device's reliability.

- Note:
1. Internal impedance of the drive source should be more than 1kΩ.
 2. Allowable value when the output transistor is in OFF state.
 3. Allowable value when the output transistor is in ON state.



HA16605W

Electrical Characteristics

Item		Symbol	Test Condition	Min.	Max.	Unit	Application Terminal	Note
Input Voltage	Low	VIL		—	0.6	V	CP, EM	1
	High	VIH		2.8	—			
Input Clamp Voltage		VIC	IIC = -12mA	-1.5	—	V	CP, EM	
Output Voltage (Low Level)		VOL	VCC = 4.5V, IOL = 2mA	—	0.3	V	FDc, WTc	
			VCC = 4.5V, IOL = 75mA	—	0.7	V	IG, EV, M, ALM	
			VCC = 4.5V, IOL = 100mA	—	0.7	V	RUN	
Input Current	Low	IIL	VCC = 5.5V, VIL = 0V	-200	—	μA	CP, EM	
	High	IIH	VCC = 5.5V, VIH = 5.5V	—	100	μA		
Output Current (High Level)			VCC = 5.5V, VOH = 8.5V	—	0.2	μA	FDc, WTc	
			VCC = 5.5V, VOH = 20V	—	50	μA	IG, EV, RUN, M, ALM	
			VCC = 5.5V, VOH = 25V	—	1.0	mA		
Comparator Input Bias Current		IIB	VCC = 5.5V, VI = 0V	-250	—	nA		2
Comparator Input Offset Voltage		VIO	VCC = 5.0V, Vref = 1.4V	—	10	mV		3
Comparator Common Mode Input Voltage		VCM		0	VCC - 1.6	V		3
Supply Current		ICC	VCC = 5.0V	—	70	mA		
Power Supply Voltage		VCC		4.5	5.5	V		
Maximum Clock Frequency		fCP		10	—	kHz		

- Notes: 1. Low and High signal levels applied to terminals CP and EM.
 2. This item is applied to the inputs of comparators. FD+, FD-, T, ST and WT.
 3. These items are applied to FD+ ↔ FD-, T ↔ ST and T ↔ WT of the comparators.



Signal States and Levels of I/O Interface

Interface Block	Terminal Name	Signal State	Signal Level
Decoder	P	Connect to VCC at "1" level input, and to GND at "0" level input.	$V_{IH} \geq 4.0V$
	S		$V_{IL} \leq 2.0V$
Clock Interface	CP		$V_{IH} \geq 2.8V$
Emergency Input	EM	Emergency state is detected at Low level input on this terminal, and ALM output turns ON.	$V_{IL} \leq 0.6V$
	FD \oplus		High level on this terminal turns the sequence to the flame detected state.
Comparator	ST	Low level on the interting input turns the ALM output ON.	$0 \leq V_{CM} \leq V_{CC} - 1.6V$
	WT	Low level on the interting input turns all the sequence Reset.	
Driver	EV, IG, RUN, M, ALM	Output OFF equals to "1" level. Output ON equals to "0" level.	

System Connection

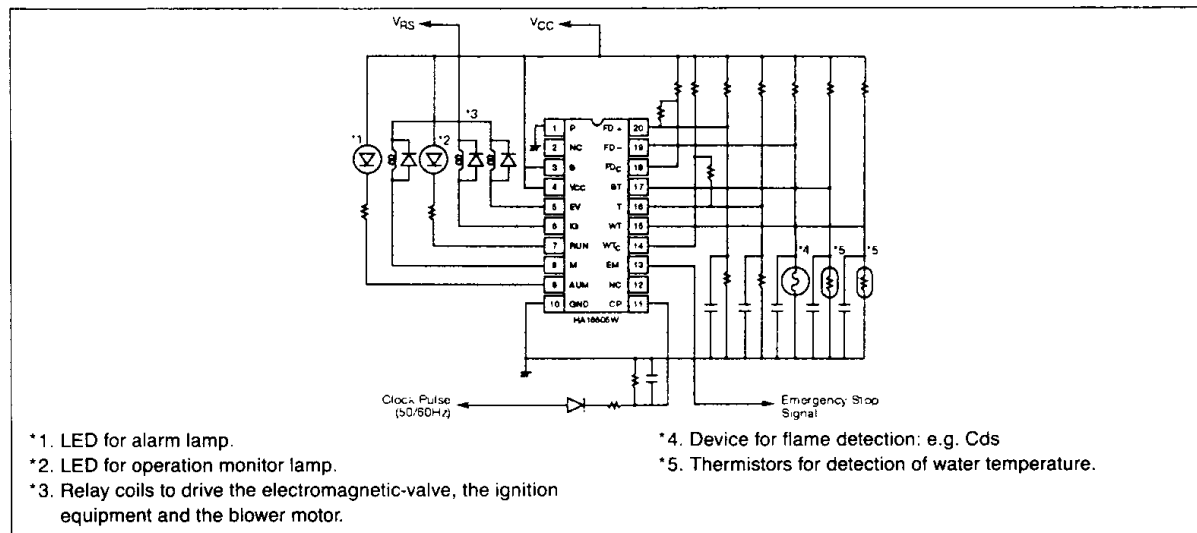

Sequence Time Table

Item	Sequence Code			
	P 0	P 1	P 0	P 1
	S 0	S 0	S 1	S 1
Pre-purge Timing	8 sec	17 sec	17 sec	68 sec
Ignition Timing *1	9 MAX	4 MAX	8 MAX	—
Post-ignition Timing	—	—	17	170
Safety Switch Timing	9	4	8	—
Ignition Return	None	None	Possible	—
Pre-purge Return	Provided	Provided	Provided	—

Note: *1 Ignition should be turned off at the same time of flame ON.
 *2 All values shown in this table are measured under the condition of that: clock input: f = 60Hz (commercial frequency)

Sequence Chart

P:O, S:O

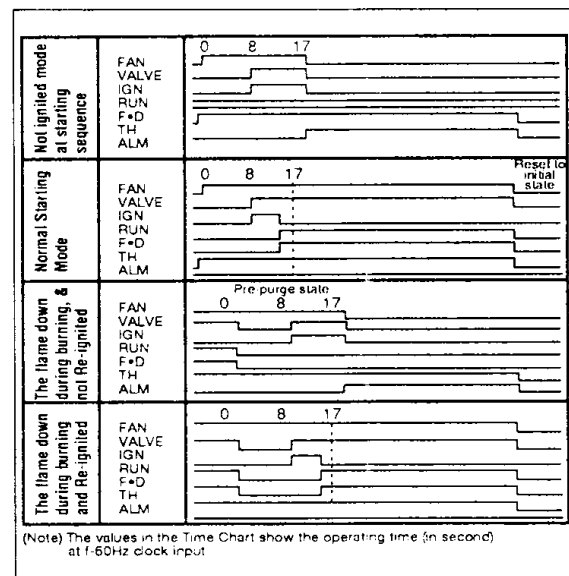

Sequence Chart (Cont'd.)

P:1, S:0

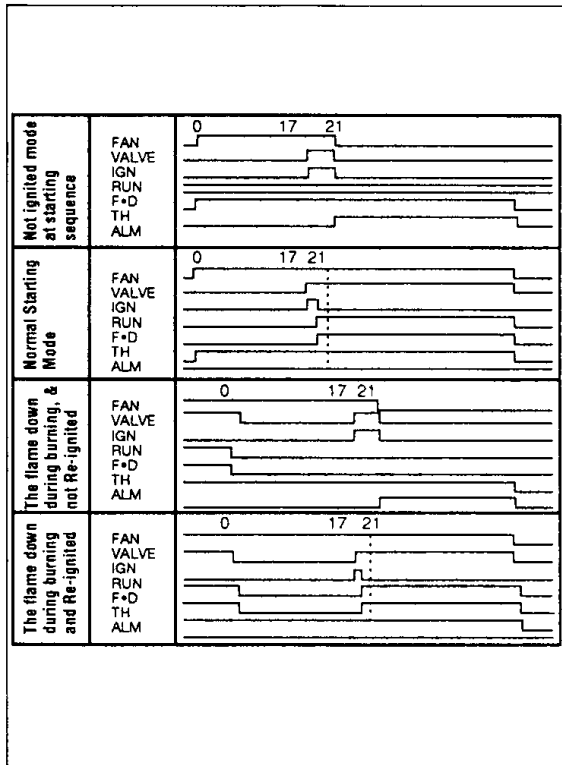

P:0, S:1

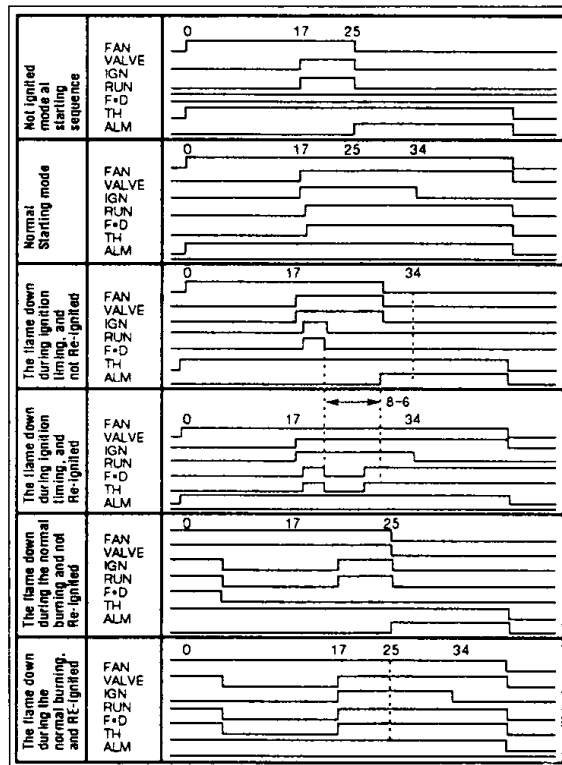

P:1, S:1

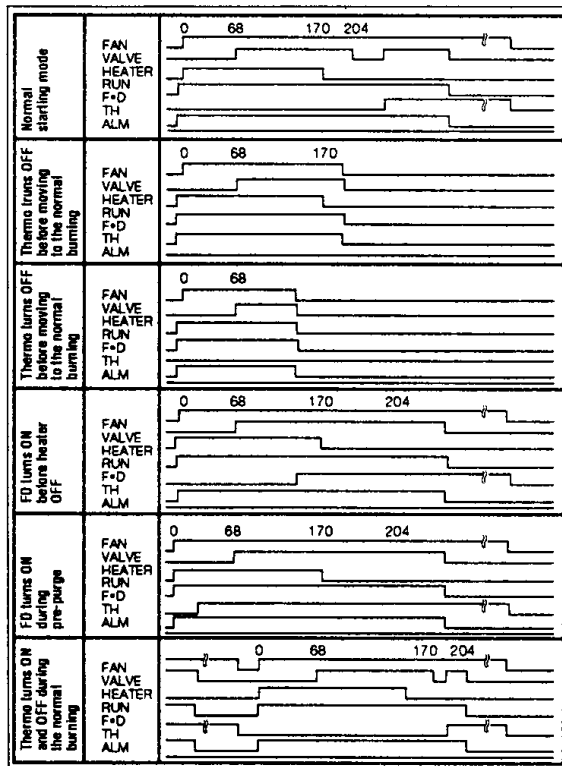

P:*, S:* (in abnormal conditions)

